

# User's Manual

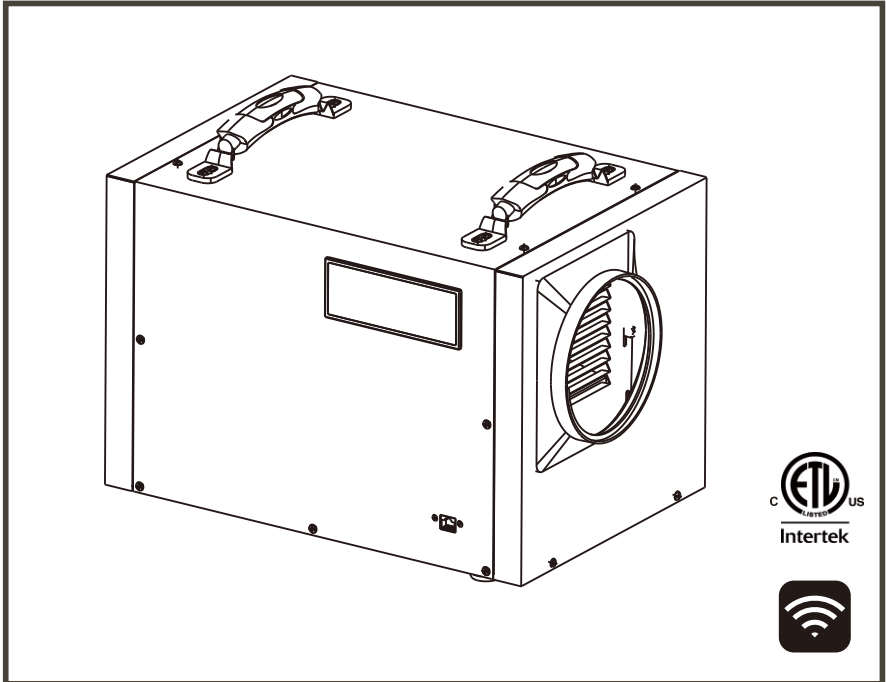

## **Guardian SN55** **Guardian SN55S**

**Abestorm Solutions INC.**

Add: 8605 SANTA MONICA BLVD#79525  
WEST HOLLYWOOD, California, 90069 USA

E-mail: [sales@abestorm.com](mailto:sales@abestorm.com)

Note: as we keep upgrading our product, we reserve the right to modify the product without notice in advance.

# ■ Table of Contents

Warranty Registration .....	2
Safety Notes .....	2
Identification .....	3
Electrical Supply .....	3
Principle of Operation .....	3
Installation .....	3
Key Functions .....	4
Indicator Lights .....	5
Remote Control .....	6
Operating Instructions .....	7
Diagram .....	7
Maintenance .....	8
Dehumidifier Storage .....	8
Ducted Applications .....	9
Troubleshooting .....	10
Spare Parts .....	11
Warranty Information .....	12

## ■ Warranty Registration

Congratulations on purchasing a new Guardian Dehumidifier. Your new dehumidifier comes with an extensive warranty plan. To register, simply fill out and return the warranty form provided in the dehumidifier box.

Be sure to note your dehumidifier serial number as you will need it for registration.

## ■ Safety Notes

- The Guardian Series Dehumidifier must always be connected using a grounded electrical connection (as required for all electrical appliances). If non-grounded wiring is used, all liability reverts to owner and the warranty is voided.
- Guardian Dehumidifiers should only be maintained and repaired by a qualified technician.
- Guardian Dehumidifiers are only intended for operation when oriented with the unit sitting on its feet and level. Operating the unit in any other orientation could allow water to flood electrical components.
- Always unplug dehumidifier before moving.
- If there is a chance that water flooded the dehumidifier, it should be opened and allowed to dry thoroughly before reconnecting to electrical power and restarting.
- To ensure proper operation, neither the inlet nor discharge should be positioned against a wall. The inlet requires a minimum of 6' clearance and the discharge requires a minimum of 6' clearance.
- For better use of the dehumidifier, both air inlet and air outlet should be facing the open area of the space.
- Do not insert your fingers or any object into the inlet or discharge.
- All work on the dehumidifier should be done with the unit "off" and unplugged.
- Do not use water to clean the exterior of the machine. To clean unit, unplug from power, then use a damp cloth to wipe exterior.
- Do not stand on the machine or use it as a device to hang clothes.

## ■ Identification

For future reference, write down the model, serial number, and date of purchase for your dehumidifier. This is extremely helpful if you need to seek assistance in the future. The data label on the side of your unit has the key characteristics of your specific machine.

**Model Number: Guardian SN55 / Guardian SN55S**

**Serial Number:** \_\_\_\_\_ **Date of Purchase:** \_\_\_\_\_

For additional questions concerning your dehumidifier, the following options are available:

- Contact your installing contractor
- E-mail: [sales@abestorm.com](mailto:sales@abestorm.com)

## ■ Electrical Supply

Power Supply: 115 V, 60 Hz AC, Single Phase

Outlet Requirement: 3-Prong, GFCI

Circuit Protector: 15 Amp

**WARNING:** 240 Volts AC may cause serious injury from electric shock.

To reduce risk of injury:

1. Disconnect electrical power before servicing .
2. Only plug unit into grounded electrical circuit .
3. Do not use an extension cord.
4. Do not use a plug adapter.

## ■ Principle of Operation

The Guardian Series Dehumidifier utilizes its integral humidistat to monitor the conditioned space. When the relative humidity goes above the selected set point, the dehumidifier will energize. Air is drawn across an evaporator coil, which is cooler than the dew point of air. This means moisture will condense out of the air. The air is then reheated through the condenser coil and distributed back into the room.

## ■ Installation

The area to be controlled should be sealed with a vapor barrier. If unit is installed in a crawlspace, all vents should be sealed.

**WARNING:** Do not install your dehumidifier in a corrosive environment. Some liquid vapor barriers dry via “solvent evaporation”. Always make sure that barrier is completely dry and area is thoroughly ventilated before installing dehumidifier.

**Step #1: Place dehumidifier on a level surface.**

Do not place directly on vapor barrier. For example, use blocks, or pavers to create a level surface.

If the unit is handled in such a manner that the compressor did not remain in the upright position, it is necessary to place on a level surface and wait a minimum of 2 hours before turning the unit "on"

NOTE: The dehumidifier can't sit directly on floor unless the unit is feeding directly into a sump pump next to it. Elevation is required to allow gravity flow of condensate water drain.

## Step #2: Set Up Drain Line

The drain line should be routed to a suitable drain on the outside. It must flow down to a drain without any loops, dips, or valleys.

### Recommended Drain Option-Transition to PVC Pipe

1. Cut a piece of 3/4" OD PVC that is approx. 6" long.
2. Insert PVC into a 3/4" elbow, then attach to a 3/4" OD length of PVC to drain. (Note: Keep the length of PVC drain pipe to a minimum).
3. Insert the open end of the tubing into the 3/4" pipe so that it does not extend into the elbow fitting. For proper flow, a minimum downward slope of 1" per 10' run is required. (Note: If a proper downward angle is not possible, then it is recommended to use a Guardian SNS65S which includes an integrated pump).
4. Support the PVC tubing so that it maintains a smooth downward flow to drain.
5. *Always test the drain before leaving the installation area.*

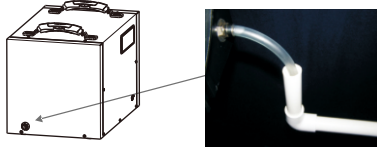

Drain Tube – 12 Inches Long, 19 mm OD.

Step #3: Plug unit into 15 amp grounded circuit.

## Key Functions



### 1. Power Key

- Use this button to turn the dehumidifier on and off. Press once to turn machine on. You will hear one beep and the  Power light will illuminate green. Press the power button a second time and you will hear one beep as the machine shuts down. Note that there is a one minute fan delay on shutdown.

## 2. Arrow Buttons

- Use the up and down arrow button to set the desired humidity setpoint on the display screen.

 The setpoint can be any number between 35-90%. Creating a setpoint means that when the indoor humidity is lower than the set point, the machine will stop automatically. Conversely, when the indoor humidity is higher than the set level, the unit will operate. **NOTE: The humidity levels displayed are approximate only (+/- 5%)**

## 3. Continuous Mode

- To switch into continuous mode, simply use the down arrow to set the humidity below 35%. The Cont. light should illuminate green on the display board to indicate that you have successfully switched into continuous mode. The display screen will show "CO".

• When set to continuous, the dehumidifier will run constantly, regardless of the humidity level. To stop the machine, turn the unit off or switch back to normal humidistat operation. If you would like to switch back to normal humidistat operation, simply move the setpoint above 35%.

## 4. Wi-Fi Connection +

- Hold the "UP and DOWN" key combination to activate the Wi-Fi Connection function. For details, please refer to the "New Abestorm-C App Wi-Fi Connection Guide".

# Indicator Lights

## 1. Humidity Display Screen

- The display screen has two functions:
  1. When the unit is powered on, it shows the humidity of the space.
  2. While setting the desired humidity level, the screen will show the set humidity. After a brief delay, the display will revert to current humidity level.

## 2. Power Indicator Light

- This light indicates that the unit is properly powered on and ready to operate. Always make sure the unit is "off" prior to performing any service.
- When the power light is blinking, it means that the unit has reached the humidity setpoint.

## 3. Continuous Mode/AutoDefrost Light

- When this light illuminates green, it indicates that the dehumidifier is set to continuous operation mode.
- When the light glows red, it means the unit is in auto defrost mode and clearing the evaporator coil of any ice buildup.

## 4. Compressor Light

- When the compressor light glows red, it indicates the compressor has been initiated but is currently warming up.
- Once the compressor light switches to green, it indicates the compressor is in working status.

## 5. Wi-Fi Light

The light remains off when the Wi-Fi is not connected, flashes when the Wi-Fi is connected, and stays illuminated when the Wi-Fi has been successfully connected and is operating normally.

# Remote Control Instructions

Guardian Dehumidifiers can be controlled using an optional remote accessory. The Guardian Remote Control connects to your Guardian Series Dehumidifier via a 25' CAT 5 cable. The remote control contains an integrated sensor which gives you multiple options for remotely controlling your unit, in addition to monitoring the conditions surrounding the dehumidifier.

One application for the remote control is to install the dehumidifier in one room with the conditioned air ducted into a second room that contains the remote. For example, the dehumidifier could be installed in a laundry room and ducted into a living room. The remote would then be mounted in the living room so the remote sensor can control the humidity and provide easy controls for the user.

Another useful application for the remote control is if the dehumidifier is in area that's difficult to access on a regular basis. For instance, if your dehumidifier is installed in your crawl space, the remote could be mounted in your living space or garage. This provides you with an easy way to monitor the dehumidifier.

### 1. On/Off (Power) Button



Press the on/off button and the machine will start running (one beep). Press the button again to turn the machine off.

### 2. Up Button / Down Button

Use the Up and Down arrow buttons to adjust the humidity level.

### 3. Mode M

Use the Mode button to switch between dehumidification and a ducted application.

- The  symbol on the display board indicates the sensor on the remote control is being utilized.
- The  symbol on the display board indicates the sensor on the dehumidifier is being utilized.

### 4. Temperature T

Press the temperature button to display the current temperature on the screen. Press the button again to turn off the display.

### 5. Continuous C

Press this button to switch the unit into continuous mode. **Cont.** will appear on the display to indicate continuous mode.

### 6. Drain Pump P

Use this button if the unit will not be in use for an extended period of time. Pressing the drain pump button will remove water from the pump reservoir, so the unit can be safely moved or stored. THIS FUNCTION IS ONLY AVAILABLE ON THE Guardian SNS65S / Guardian SNS90 / Guardian SNS100 / Guardian SNS120 model.

*NOTE: Symbols indicated above will only appear when the dehumidifier is powered on.*

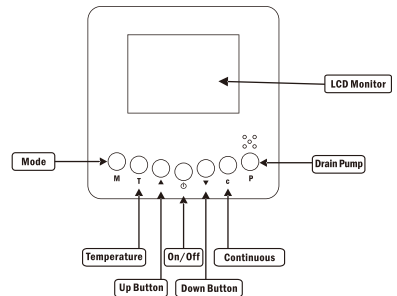

# Operating Instructions

## 1. Start the Machine

Press the power key to turn the machine on.

## 2. Adjust the Settings

Use the up and down arrow keys to adjust your desired setpoint (typically 50-55%).

## 3. Stop the Machine

Press the power key again and the machine will stop. Note the fan will continue to operate for 1 minute after the unit has turned off. NOTE: Do not disconnect the power cord to force unit to stop. Always use the power button.

## 4. Water Drainage

During normal operation, the dehumidifier will automatically drain by the force of gravity. If you want to move or store your machine, wait at least 10 minutes to allow the machine to completely defrost, then lean unit gently towards drain to ensure that it is completely drained.

# Diagram

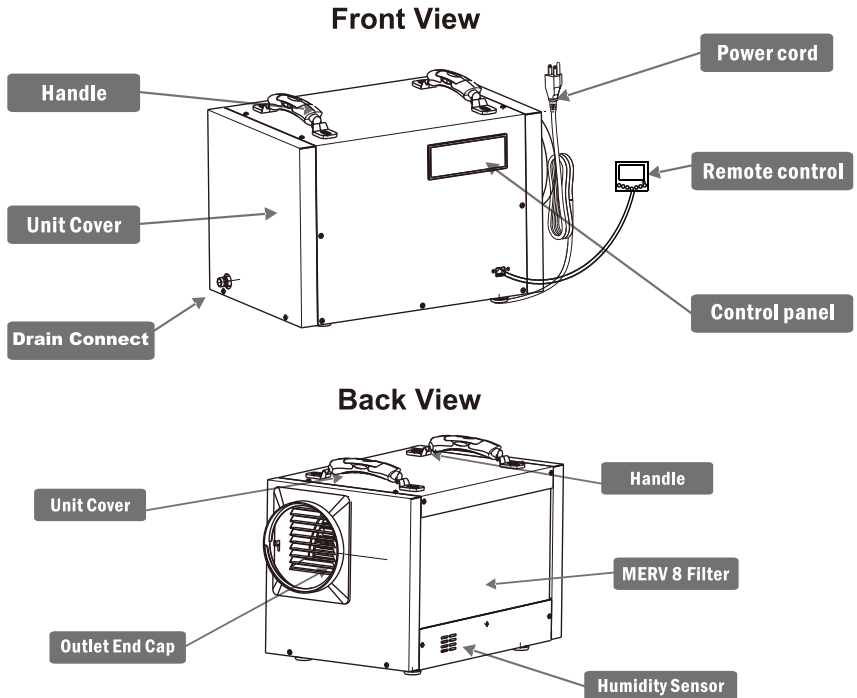



## Maintenance

**WARNING:** Always unplug the unit before doing any maintenance.

### ✓ Cleaning the machine body

Use a soft damp cloth to clean exterior of unit. Do not use any soap or solvents.

### ✓ Replacement filter and steps

1. As shown in the figure above, tilt the filter into the filter slot.
2. Push the filter upwards until it touches the top of the air filter slot.
3. Push the bottom of the filter into the filter groove.
4. Let the filter slide down freely.

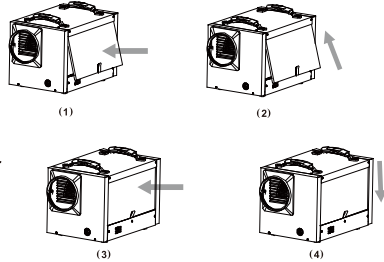

### ✓ Cleaning the filter

1. Unplug the unit.
2. Push up the filter.
3. Clean the filter mesh by vacuuming or washing with warm water (no soap or solvents).
4. Be sure filter is completely dry before restarting unit.

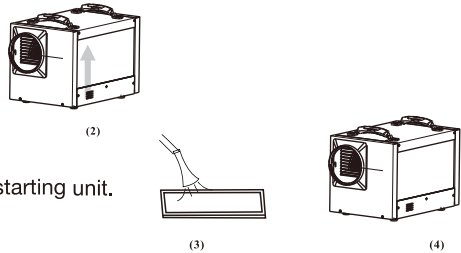

### ✓ Coil Maintenance

- Once per year, clean the coils with an approved coil cleaner.
- Coil cleaner should be a self rinsing, foaming cleaner such as WEB® Coil Cleaner.

## Dehumidifier Storage

If the unit will be stored for an extended period of time, complete the following steps:

1. Turn off the unit and allow to dry.
2. Wrap and secure the power cord.
3. Cover the filter mesh.
4. Store in a clean, dry space.

## Ducted Applications

Ducting the dehumidifier allows the unit to be in one room while conditioning an adjacent room. The supply grille is designed for 6" flex ducting. Be sure to secure the ducting with tie wrap. Also, keep in mind that the supply ducting can be screwed into an adapter if necessary.

## Ducting Installation

- Maximum length for ducting= 6'

Note: The supply duct adapter is standard on all units.

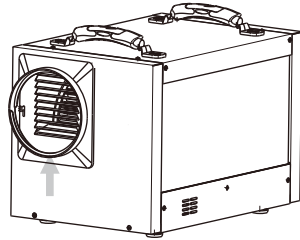
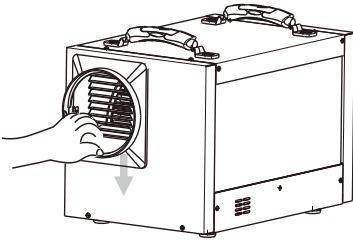

### Removing Supply Duct Adapter

If it is necessary to remove the adapter, place hand at bottom of adapter and use your fingers to pull out and down on base of adapter. This will lift hooks out of cover holes.

### Installing Supply Duct Adapter

To install adapter, line up with holes on the side of unit and push up from base of adapter.

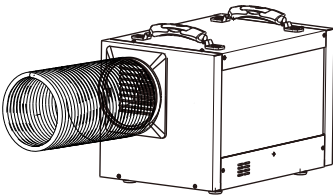

### Flex Duct Installation

Rotate the flex duct counter-clockwise.

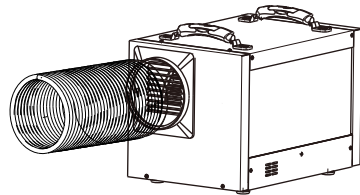

### Flex Duct Removal

Rotate flex duct clockwise.

# Troubleshooting

Symptom	Cause	Solution
Machine Won't Run	Power Supply	Verify that there is power to the outlet and that the plug is properly installed in outlet
	Room Temperature Over 104 °F (Display HI) or Below 33.8 °F (Display LO)	The unit is outside the operating temperature range. Modify the room conditions so the temperature is between 33.8 °F - 104 °F and operation will commence.
Low Air Flow	Air Filter is Clogged	Clean the filter mesh according to instructions listed in manual.
	Air Inlet or Outlet is Blocked.	Clear the blockage from inlet or outlet.
Loud Noise	Machine Is Not Level	Move the dehumidifier to flat, firm ground.
	Filter Mesh is Blocked	Clean the filter mesh according to instructions listed in manual.
Trouble Code: E1	E1 = Humidity Sensor Issues	Check to ensure that wire is connected at both ends. If no issues are visible, the sensor may be faulty.
Trouble Code: HI or LO	Room Temperature Over 104 °F or Below 33.8 °F (Display LO)	The unit is outside the operating temperature range. Modify the room conditions so the temperature is between 33.8 °F - 104 °F and operation will commence. If room conditions are with in temperature range,replace defective sensor.
Trouble Code: E3	Abnormal Coil Temperature	Contact Your Installer for Assistance
Trouble Code: E5	Refrigerant Leak	Contact Your Installer for Assistance

## Guardian SN55 / SN55S Spare Parts

<b>All Guardian Models-Parts</b>	
<b>Part#</b>	<b>Description</b>
G-100	Remote Control Package(cable+remote)
G-101	Remote Control
G-102	Remote Control Cable,25'
G-107	Fiexible Supply Duct,72"
G-108	Main Control Board
G-109	Display Board
G-110	RH/Temperature Sensor
<b>Guardian SN55 / SN55S-Parts</b>	
<b>Part#</b>	<b>Description</b>
G-500	Fan Motor
G-501	Complete Fan Assembly
G-502	Fan Capacitor
G-503	Compressor
G-504	Compressor Capacitor
G-505	Coil Assembly
G-508	RH/Temperature Sensor Cable
G-509	Display Cable
G-510	CAT 5 Prot Internal Cable
G-513	Foot,adjustable
<b>Guardian SN55 / SN55S-Filters</b>	
<b>Part#</b>	<b>Description</b>
G-517	MERV-8 Filter
G-518	HEPA Filter
G-519	Carbon Filter

## ■ Limited Warranty

This limited warranty starts from the date of purchase. Abestorm Solutions Inc. warrants to the original purchaser that this Abestorm product is free from manufacturing defects in material or workmanship for the limited warranty period of:

**Six (6) Month parts and labor.** This includes the shipments charges for replacement parts or unit.

**One (1) year parts and labor.** This does not include the shipment charge to send the defective product back to be repaired or replaced.

**Three (3) years parts and labor on Refrigeration System ONLY** (Compressor, Condenser, and evaporator). Transportation cost, not included.

**Five (5) years parts on Refrigeration System ONLY**(Compressor, Condenser, and evaporator). Transportation cost, not included.

This limited warranty is valid only on products purchased from the manufacturer or Abestorm authorized dealer and operated, installed, and maintained according to the instructions included in this user guide or furnished with the product. Abestorm Solutions Inc will not provide in-home service during or after the warranty period. You may be responsible for the shipping charge to bring the product to the manufacturer for service.

To receive warranty service, the purchaser must contact Abestorm at (888) 276-9833 or sales@abestorm.com. A proof of purchase or order number is required to receive warranty service. During the applicable warranty period, a product will be repaired or replaced at the sole option of Abestorm.

**IMPORTANT NOTICE:** Keep the item's packaging in case warranty service is required.

## ■ Limited Warranty Exclusions

This limited warranty covers manufacturing defects in materials or workmanship encountered in normal household, commercial or noncommercial use of this product and shall not cover the following:

- Damage occurs in uses for which this product was not intended for.
- Damage caused by unauthorized modification or alteration of the product.
- Cosmetic damage including scratches, dents, chips, and other damage to the product's finishes.
- Damage caused by abuse, misuse, pest infestation, accident, fire, floods, or other acts of nature.
- Damage caused by incorrect electrical line current, voltage, fluctuations, and surges.
- Damage caused by failure to perform proper maintenance of the product.

The use of this product in SPA or a room with OUTDOOR POOL invalidate or voids limited warranty.





**ABESTORM**

# WARRANTY REGISTRATION CARD

ORDER NUMBER: \_\_\_\_\_

MODEL: \_\_\_\_\_ SERIAL #: \_\_\_\_\_

INSTALLER: \_\_\_\_\_ REGISTRATION DATE: \_\_\_\_\_

NAME: \_\_\_\_\_

ADDRESS: \_\_\_\_\_

CITY: \_\_\_\_\_ STATE: \_\_\_\_\_ ZIP: \_\_\_\_\_

PHONE #: \_\_\_\_\_ EMAIL: \_\_\_\_\_

*return to:  
Abestorm solutions*



▶ If you have any questions, please feel free to contact us at (888)276-9833 or visit [www.abestorm.com](http://www.abestorm.com)

▶ Register your unit for warranty using this link: <https://www.abestorm.com/service-warranty>

